

POWERED by  
**HONDA**



CE



# PCX Series

## Plate Compactor PCX 450

- heavyweight, forward-moving plate compactor for maximum compaction
- robust, cast base plate with rounded edges and self-cleaning function
- patented vibration neutralisation of the operating handle
- foldable handle, perfect for transport and storage
- strong protective frame with lifting bow



## PCX 450

- heavyweight, forward-moving plate compactor with HONDA petrol engine and all-round protective frame with lifting bow
- designed for maximum compaction, ideal for contracting and rental use
- robust, cast base plate with rounded edges and self-cleaning function
- high-frequency vibration unit (16.5 kN at 101 Hz)
- patented vibration neutralisation of the handle for long periods of use of the plate compactor
- foldable handle - can be lowered to work under obstacles and near formwork. In addition it enables space-saving storage as well as transport.
- optionally with water kit (water tank & water spray system)

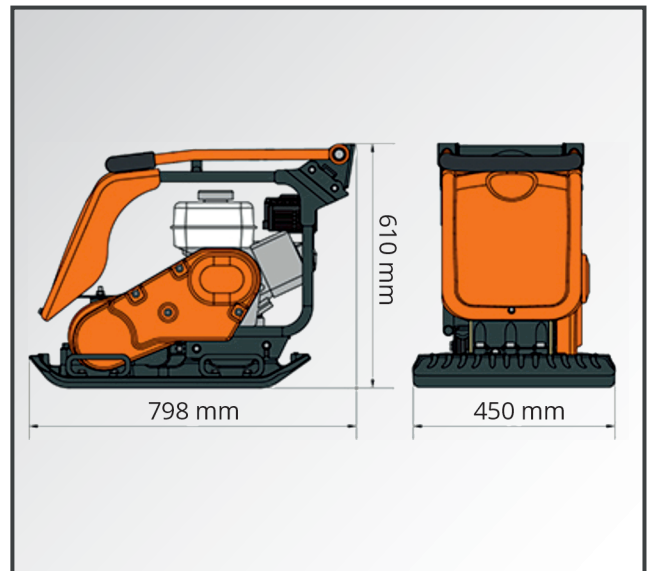









\*optionally with water kit (water tank & water spray system).



Designed for maximum compaction, ideal for contracting and rental use. Very long usage times thanks to low hand-arm vibration.



A foldable chassis for easy transport is also available as an accessory: Order-no. BEOPP/50/DIO

| Plate Compactor                   | PCX 450                 | Logistic Data   |
|-----------------------------------|-------------------------|---|
| Engine                            | HONDA GX160             |  REF BEPC4513E           |
| Fuel                              | Petrol                  |  798 x 450 x 610 mm + EP |
| Power                             | 5.5 HP / 4.0 kW         |  [PU 1] 86 kg + EP       |
| Static pressure                   | 382 kg/m <sup>2</sup>   | <br>5 031403 409263      |
| Centrifugal force / Frequency     | 16,5 kN at 101 Hz       |  REF BEPC4513EW          |
| Travel speed max.                 | 23 m/min                |  798 x 450 x 610 mm + EP |
| Plate size                        | 696 x 450 mm            |  [PU 1] 96 kg + EP       |
| Vibration level                   | 1.90 m/sec <sup>2</sup> | <br>5 031403 409423      |
| Operating time max.               | 831 min                 |   |
| Sound power level L <sub>WA</sub> | 105 dB(A)               |   |
| Weight approx. (N.W.)             | 86.0 kg   96.0 kg*      |   |
| Order-no.                         |                         |   |
| without water kit                 | BEPC4513E               |   |
| *with water kit                   | BEPC4513EW              |   |